

Klaus Hünig

The Copernicus- Planetary *Assembly instructions*

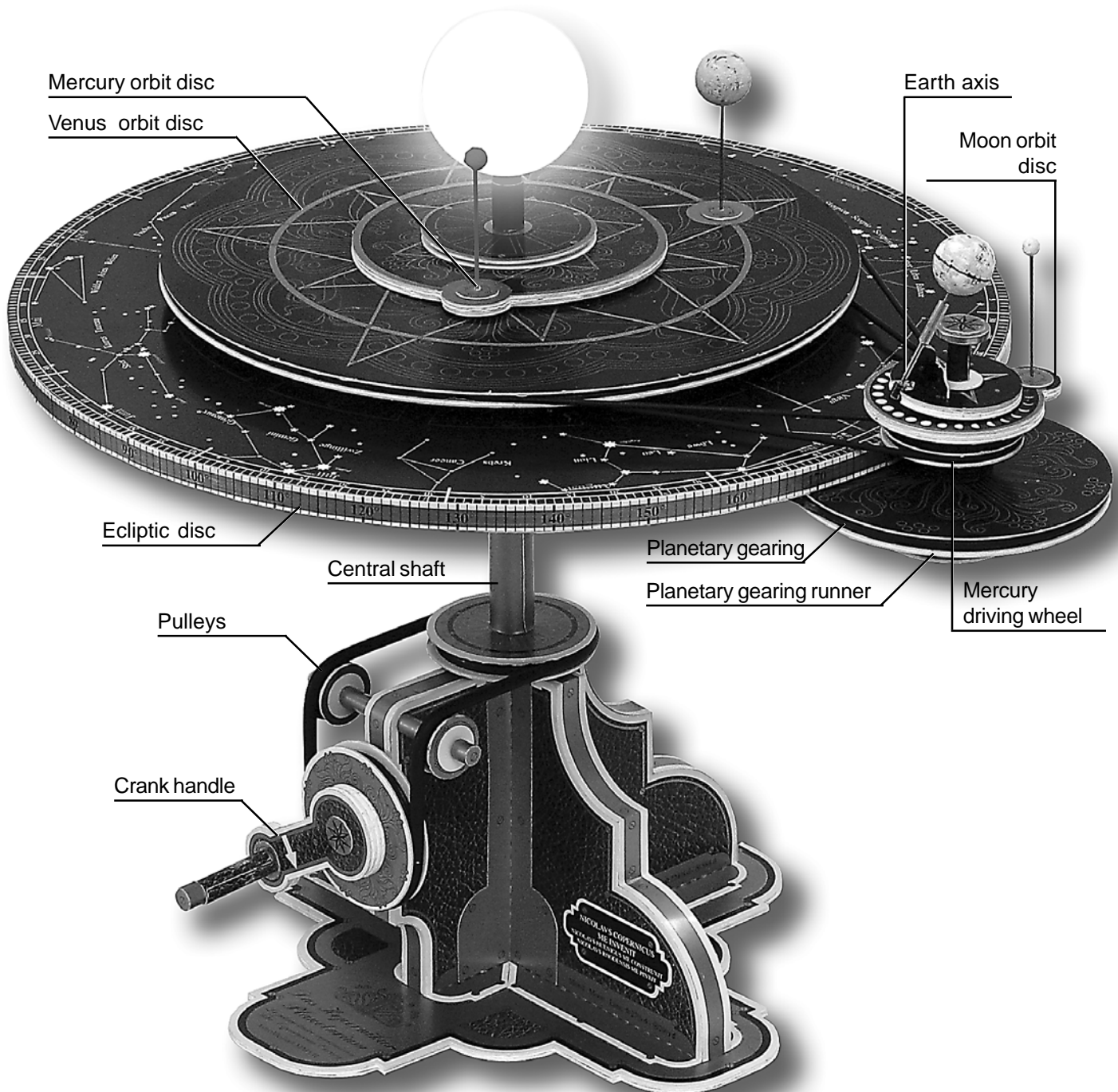

Hands-on-science series

Mechanical planetaria were already known in ancient Greece, though the planetary orbits with their loops, that the Ptolemaic world model constructed around a stationary earth at its centre, most likely cannot have been replicated mechanically. The most famous example is the Antikythera mechanism, discovered in a shipwreck, which was much like a calculating machine. It is said that Archimede, too, was able to demonstrate mechanically the orbits of Sun and Moon.

Almost all of the mechanical planetaria we know are based on the ideas of Nicolaus Copernicus (1473 -1543), who regarded the Sun as the centre of the world. He proclaimed that the Earth does not remain in place but rather moves in three ways: it revolves once in 24 hours, orbits around the Sun once per year on a circular path and, in a third movement, turns its axis in such a way that it always points in the same direction and not towards the Sun. Despite heavy resistance, especially from the church, this world model continued to spread and, through improvements made by numerous scientists, evolved into the generally accepted scientific world model of today. One of these scientists was Johannes Kepler, who discovered the elliptical nature of the planetary orbits.

At the beginning of the 18th century the Earl of Orrery and other English aristocrats asked watchmakers to manufacture crank-driven mechanical models of the planets, which are called orreries since that time. One of the largest and most famous movable planetariums was built by the Frisian Eise Eisinga in the years 1774 to 1781 in the town of Franeker, where it is still exhibited.

Today the name „planetarium“ is mostly used for projection planetariums like those that were first constructed by the Zeiss optical company in Germany at the beginning of the last century. These project the stars onto the inside of a large dome.

The AstroMedia* Copernicus Planetarium stands in the tradition of the mechanical, crank-driven planetary models that are exhibited by selected museums as masterpieces of the watchmaking and precision engineering arts. Its simple drive belt design, the robust cardboard construction and the affordability of an assembly kit make this interesting and instructive device available to a larger public once again.

Things Needed For Assembly:

- **Cutter knife or scalpel** with a slender blade tip.
- **All purpose glue.** This may be used for all parts. Solvent-based glue has advantages over water-based glues: it will not warp the cardboard, dries much faster and adheres better to the lacquered cardboard surfaces. Tip: you may need several tubes/bottles.
- **Instant adhesive** with a comfortable drying time (meaning: not too fast) for glueing cardboard to plastic or metal and, should this become necessary, for constructing NBR-rubber drive belts. Please pay careful attention to the handling and safety precautions particular to instant glues!
- Quick-drying **white wood glue** – this can be used instead of all purpose glue for the larger parts, but does not work so well on lacquered surfaces. Drying times will be much longer, but in return you will get stiffer bonds.
- Fine **sandpaper** for sanding off projecting cardboard edges.
- A **cutting board** made of thick, completely flat cardboard, wood or plastic material. Best are the “self-healing“ cutting mats whose cuts close by themselves again.
- A **ruler or set square**, for cutting, measuring and checking right angles (for this purpose the right-angled corner of a sheet of paper will also do).
- A pair of **pliers** or a **wire cutter** for shortening the nails, if necessary. For holding or pressing small parts, tweezers or clothes pegs can be useful.
- A **steel pin** and a **sewing needle**, or, even better, a 1 mm hand drill for widening the indicated holes in the steel pin bases to a diameter of 1 mm.
- **Sellotape** for reinforcing cardboard surfaces.
- A **round wood file** will be of good use for widening the holes in the grey cardboard discs.
- Light, non-resinous **machine or silicone oil** (do not use food oil!) against squeaking noises where synthetic discs move on wooden surfaces.

OPTIONS: The word **OPTION** and italics mark assembly sections that you do not have to carry out, but may. For these steps you will need:

- A piece of **plywood** or similar material, about 21 x 21 cm, for reinforcing the base, if the orrery needs to be prepared for regular use, for example in schools.
- A thick **black marker**, white paint or correcting fluid, if you wish to colour the edges of the grey cardboard.
- **Opaque colours**, coloured felt tip pens, correcting fluid, if you wish to paint the wooden globes representing Earth, Moon and planets.

This kit contains:

- Die-cut sheets size A4: 6 sheets of unprinted grey cardboard 1.13 mm (sheets 1-6), 12 sheets printed offset cardboard.5 mm (sheets 7-18), 1 sheet printed offset paper.13 mm (sheet 19).
- Cardboard and hard paper tubes (axles and shafts): One piece 100 x 12 x 10 mm (length x outer diameter x inner diameter), one pc. 27 x 8.8 x 7.5 mm, one pc. 38 x 6.5 x 5 mm, one pc. 14.5 x 34 x 32 mm.
- Round wooden sticks (axles and shafts): one piece 8 x 240 mm (diameter x length), one pc. 4 x 70 mm, 2 pcs. 4 x 56 mm, one pc. 4 x 38 mm.
- Plastic bearing discs with hole (axle and shaft bearings): 6 pcs. 14 x 4.1 mm, 2 pcs. 20 x 8.2 mm, 2 pcs. 20 x 8.6 mm, 2 pcs. 25 x 4.1 mm, 2 pcs. 50 x 29.3 mm, 2 pcs. 55 x 34.3 mm.
- Spring steel pins (mounting for Moon and planets): 4 pcs. 1 x 43.5 mm.
- Wood globes (Moon and planets), pre-drilled: 2 pcs. 16 mm diameter, one pc. 6 mm, one pc. 4.5 mm.
- Brass tube (Earth axis bearing): one pc. 1.5 mm outer x 1.1 inner diameter x 10 mm length.
- Neodymium magnet (Earth rotation drive): one pc. 15 x 2.5 mm.
- Silicone tube (Earth rotation drive): one pc. 2.8 mm outer x.8 inner diameter x 12 mm.
- NBR-rubber drive belts: one pc. 4 mm diameter, 5 pcs. 2 mm diameter.
- Ferrite magnets (Sun mounting): 2 pcs. 8 mm diameter x 4 mm
- LED glow globe (Sun): one piece 45 mm diameter.

The relevant mechanical parts of the Copernicus Planetarium

In the Copernicus Planetarium power is transferred by way of a belt transmission, consisting of groove wheels and round drive belts made of NBR-rubber. A crank drive with handle supplies the necessary power.

Shaft is the term used for those cardboard tubes and round wooden sticks which are attached to at least one wheel in such a way that they turn with it – as opposed to axles, which do not turn, enabling wheels or hollow shafts to turn on them. A shaft can transmit forces, an axle cannot.

Plastic bearing disc is the term for the discs made of hard white plastic (PVC). The hole serves as a rotary bearing for axles or wheels, the surface as a sliding bearing. The code gives outer x inner diameter, for example 14 x 4.1 mm.

A driving wheel is a wheel which transmits power onto a drive belt, which drives another wheel in turn. This is then termed runner, because it is forced to run by the first one.

The large, fixed disc that carries the Sun in its centre is the ecliptic disc, which is supported by the central axle, made of wood and not visible after the completed construction. The central shaft turns on the central axle, receiving its power from the crank drive and passing it on to several drive shafts.

The group of glued-together cardboard discs moving along the edge of the ecliptic drive form the planetary gearing. Within, mounted but freely movable, lies the hollow shaft for the Earth inclination, which enables the Earth's axis to be inclined in one constant direction. Yet within lies the shaft for Earth rotation; each one moving at its own, particular speed.

Tips for successful assembly – please read before starting

Tip 1: The assembly instructions are divided into many small steps containing detailed instructions. It may at first appear to be a lot of text, but it does make the construction transparent and leads to good results in an easy way. Please read each step completely before applying it and take your time. The Copernicus Planetarium is an astronomical model of high quality with a drive system that is quite complex but easy to build. The more time you do allow yourself in construction, the better and more beautiful it will turn out to be. Important: keep to the assembly order.

Tip 2: Each part on the imprinted sheets is marked with its name and code, which consists of a letter and number, according to assembly succession. It is only on the blank grey cardboard sheets that the code needs to be written in, as will be explained in step 1. All parts of an assembly group carry the same letter in their code. It is best to separate only those parts from the sheets that are needed at the time; unless you write the code on the back of the parts if they do not carry one yet.

Tip 3: A few parts are marked "R" or "Reserve" – these had to be die-cut along with the others for production reasons but are not needed.

Tip 4: We recommend you do not tear the parts from the cardboard, but rather cut through the small connectors with a knife so that the edges are smooth from the onset.

Tip 5: Those lines marked with perforation cuts are all to be folded "forward", meaning: towards myself as I am looking onto the part.

Tip 6: Surfaces on which something will be glued, are generally marked grey. A tip for using solvent-based glue on small surfaces: apply glue liberally to one side, press both pieces together for a moment so that both sides are covered well with glue, pull them apart again and blow two or three times on both. Now strongly press the two parts into their correct position – the bond will hold instantly. Careful: this will work only with sol-

vent-based glues. Blowing on instant adhesives will speed up the bonding process because they react with water and therefore also with the humidity of your breath.

Tip 7: Larger glueing surfaces should be pressed while setting, for example with a few books on a plane surface, to prevent any warping.

Tip 8: Offset cardboard is processed by reel-fed printing presses and possesses a fibre direction, meaning a preferred direction in which it bends easier. That is why, before glueing together any larger parts, it is important to look for the fibre direction of the two pieces and to mark it on them accordingly before glueing them together in such a way that their directions match. This is also described in step 20. As far as the grey cardboard is concerned, you need to pay attention to this only with the very large Venus and Mercury runners.

Tip 9: If you want to do a perfect job, cover the edges of the grey cardboard discs with glue after having glued them together; this will harden them. Do this before glueing on the side guide discs made of white cardboard.

Tip 10: The top of the plastic bearing discs is smoother than the underside where you will find a tiny burr. Always glue this rougher side onto the cardboard. If the hole in the disc proves to be too tight for its axle, you can widen it by turning scissors lightly in the hole, for example. Always pay careful attention to glueing the bearing discs exactly onto the centre.

General advice on handling grey cardboard pieces and cardboard tubes:

Sheets 1 – 6 are made of grey cardboard, die-cut but unprinted. In order to identify them easily, you need to write its code on each part before separating it. Do this according to the small-scale reproductions of the grey sheets on the last page. Also write sheet 1, sheet 2, etc. on them.

The die cutting pressing machines do not produce right angled edges in the thick grey cardboard; for this reason the top of the parts is smaller than the bottom by a fraction of a millimetre. When glueing together a series of identical parts, ie. the inner bearings of the groove wheels, put the smaller top sides against one another if nothing else is indicated.

For the same reason, the disc hole diameter always seems to be a bit too tight on the underside. It is easy to widen though, if necessary, with a round file or by using the cone of a sharpened pencil, or an unopened pair of scissors by turning it within the hole, using only very light pressure. IMPORTANT: the resulting burr must be cut or sanded off.

Cardboard is a natural product, which can have noticeable tolerances in size. This applies to the grey cardboard parts as well as the tubes. If a tube will not readily fit into its disc hole, widen the hole as explained above or sand the tube end lightly.

Section A: The Pedestal

The core of the pedestal is made of two pedestal walls that lock into each other at a 90° angle, resulting in four wings which supply the necessary structural strength. Each wall is constructed of two grey cardboard pieces that are glued together with six 8 mm distance rings. The grey walls will eventually be covered with printed cardboard parts. The pedestal wall, made of parts A13, sheet 5, and A14, sheet 6, is symmetrical. The second one, made of A15, sheet 5 and A16, sheet 6, is asymmetrical. When assembled, three identical, curved pedestal wings are produced; plus a fourth, more linear wing which will carry the crank drive on its vertical side. The pedestal will be glued onto its base plate only at the end of section B.

Step 1: Separate the 12 distance rings [A1 – A12] from sheets 11 – 16, bend them into a roughly round shape and glue them together so that they overlap about 10 mm, making rings of almost 30 mm diameter. The ends need to join in a straight line without shifting to the side, so that no part of the finished ring rises above 8 mm when lying flat. Creases are no problem.

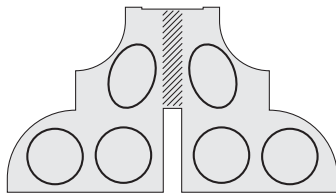

Fig. 1: Distance rings on pedestal wall 1

Step 2: Glue six distance rings on the front of pedestal wall 1 [A13, sheet 5] according to fig. 1. The hatched area has to remain open. Let dry well and press down several times while the glue sets. Now cover the upper edges of the distance rings with plenty of glue and lay pedestal wall 2 [A14, sheet 6] on it, so that the edges of both walls are exactly above one another. Tap the resulting pedestal half on your work surface with its lower edge so that both wall sides come to equal height. Check again whether none of the sides project beyond the other anywhere and lay the whole piece flat with wall 2 facing down, so that the liquid glue can run toward the new bonding area and not away from it. Use a book, or similar thing, to weigh it down.

Step 3: Take a plastic bearing disc 14 x 4.1 mm and glue it between the 2 halves of the crank shaft inner bearings [A17 and A18, sheet 5 and 6], using instant adhesive. The disc hole has to be exactly in the centre of the cardboard hole and the two cardboard pieces must be congruent. The plastic bearing disc projects at the longer edges. After drying, cut this excess plastic off cleanly.

Step 4: Remove the cardboard from the small hole and slot in pedestal wall 3 [A15, sheet 5] and glue the inner bearing of the drive axle [A17 and A18] into the small slot with

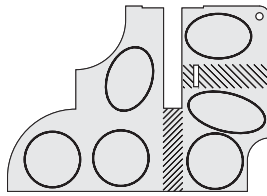

Fig. 2: Distance rings on pedestal wall 2

one of its longer edges, this is best done with instant adhesive. Now glue the remaining six distance rings onto the same pedestal wall side according to fig. 2. Again, leave the hatched areas open.

Step 5: Open hole and slot in pedestal wall 4 [A16, sheet 6]. As before, apply plenty of glue to the upper edges of the distance rings as well as to the slot in wall 4, then put it on top of wall 3 with its distance rings and inner axle bearing. This bearing has to slip into the slot with its upper edge. Now adjust the two halves until their edges line up exactly and, again, turn the pedestal half so that the glue can run toward the fresh glueing spots. Pay special attention to an exact matching of the two holes so that the pulley axle, which will eventually rest here, will not sit at a tilted angle.

Step 6: After drying, connect the two pedestal halves at a right angle by inserting the centre slots into each other. They have to be equal at top and bottom and be able to stand on the work surface without wobbling. Pull them apart a bit, or completely if you prefer, and apply glue to the points of contact, then reconnect them. Also, and without glue, insert the central axle (wooden and 8 mm in diameter) temporarily into the centre until it reaches the intersecting base. It will stiffen the construction and serve as a sort of handle in the meantime. Pay attention also that the distances of the grey cardboard pedestal walls are equal on all top sides, otherwise the outer edge strips [A32 to A35, sheet 19] will not attach easily in step 8.

Step 7: Bend forward all footlashes of the 8 pedestal wall facings [A19 to A26, sheets 7 – 10] and glue them onto the pedestal walls so that the round outside edges match exactly, that is, do not project or stand back anywhere.

TIP: You may want to glue the two wall segments A19 and A20, which carry printed text fields, to the right and left of the crank drive wall, for reasons of symmetry.

A small gap will remain at the inner corners of the base where the wall facings meet. This will be covered up later in step 10.

The edge facings for the pedestal [A31 to A35, sheet 19] do not have die-cut folding lines because they would be all too visible. That is why the next step is a combination of glueing and folding. – On their top all four pedestal wings have a recess, about 1 mm

deep. In this place the disc-shaped bearing for the central shaft will be glued later. A similar recess is located on the vertical side of the pedestal wing which will take the crank drive. We will begin with this last wing now:

Step 8: Hold edge facing 1 [A31, sheet 19] onto the top side of the crank drive pedestal wing, with the end that shows just one screw. The end of the paper strip should be about 1 mm away from the just-mentioned recess. For the moment, mould the strip to the edges without glue and just check whether the edges have the correct distance. Now apply plenty of glue to the underside of the paper's edges and glue the strip onto the pedestal edges. The strip now covers the gap between the two pedestal walls from the upper horizontal recess to the vertical side recess. Next, take facing number 2 [A32, sheet 19] and put the end that has three screws onto the short vertical piece of the same pedestal wing, just below the side recess. Mould the paper around the corner leading to the adjoining curve, so that the corner will leave a mark in the paper strip. Remove the strip and fold it cleanly and sharply where the corner left its imprint. Now mould the strip into the next curve also and then glue it onto the pedestal edges completely. The small part that sticks out beyond the pedestal end can be cut off cleanly after drying.

Step 9: Taking edge facing 3 [A33, sheet 19], put the end with two adjacent screws onto the upper horizontal part of one of the other pedestal wings, once again about 1 mm away from the recess. Mark the corner in the paper, bend it cleanly and glue this uppermost horizontal piece on. Now shape the strip into the adjoining curve up to the next corner, again mark the fold, bend it and glue this rounded section of the strip on also. Next, mould the strip onto the adjoining vertical part and push it into the corner with a knife, or other such tool, marking the strip. Bend at the mark and glue this section on. Smooth the rest of the strip over the next curved part, glue it on and cut off the excess after drying. – Now go through the same process with edge facings 4 and 5 [A34 and A35, sheet 19] and the two remaining pedestal wings.

TIP: As an alternative to painting the edges of the Moon and Mercury orbital discs white, use the left-over golden parts on sheet 19 to cover them.

Step 10: Fold forward the four corner facings [A27 to A30, sheet 19] and glue them into the inner corners, where the wall facings meet.

Step 11: Glue the two parts of the central shaft bearing [A36 and A37, sheet 3] together. **OPTION:** Paint the edges white or face them with white a strip of paper. Remove the wooden central axle from the pedestal and check whether the central shaft bearing will fit into the recess on top of the pedestal centre without problems. Slip the central shaft bearing over the central axle and apply

glue to the edges of the pedestal walls where the bearing will be. Insert the central axle into the pedestal again and push the bearing down until it fits exactly into its place above the intersecting pedestal walls. It will serve not only as the bearing for the central shaft that turns on the central axle, but will also give the needed support for the central axle. Now glue its four facings [A38 to A41, sheet 15 and 16] onto the underside of the central shaft bearing.

The pedestal is now prepared to take the crank drive.

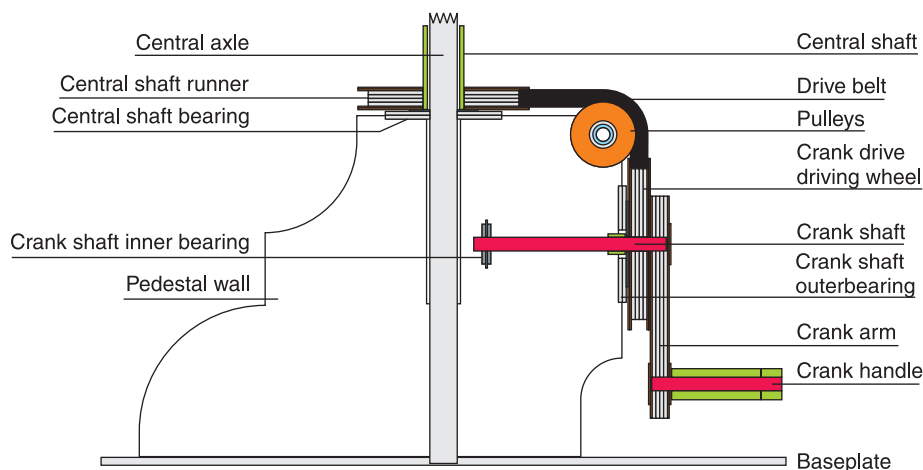

Fig. 3: Pedestal with crank drive

Step 12: Push the 70 mm long wood piece through the hole at the top of the pedestal wing so that it projects equally on both sides. You may have to widen the holes a bit. This is the pulley axle. With a pencil, mark the axle on both sides where it exits from the cardboard, and make sure that these marks are equally far from the ends. Check also that the axle is at a right angle to the pedestal wing. Now pull the wooden piece out for 5 or 10 mm, apply glue to this area and push it back in while turning it. Push it beyond the mark so that glue can be applied to the other side as well and then push it back to its original position. The pencil marks should now both be visible and the axle must project equally on both sides. Allow to dry.

Step 13: Wrap the pulley axle covers 1 and 2 [B1 and B2, sheet 19] around one of the remaining round wooden sticks without glue so that the paper strip will bend; this makes them easier to glue on. Now glue the grey end of one of the strips onto the pulley axle with the first few millimetres of its backside, directly next to the pedestal wall. Allow this to set and then put glue on the rest of the strip. Wrap it tightly into a solid, glued cylinder and push it against the pedestal wall with pressure before the glue sets, using one of the 14 x 4.1 mm plastic bearing discs. Use the same procedure for the paper strip on the other side of the pulley axle. The ends of the two axle covers will now be about 40 mm apart. This determines the correct distance between the pulleys.

Step 14: Remove the four middle parts of pulley 1 [B3 to B6, sheet 3] from the grey cardboard. First glue two parts against one another with their upper sides and then glue another part onto each side, again with its upper side. OPTION: paint edges black. Take care that the discs are congruent. Next, glue outer disc 1 of pulley 1 [B7, sheet 7] on the back of its matching and identical inner disc [B9, sheet 9] and repeat all with outer disc 2 [B8, sheet 7] and inner disc 2 [B10, sheet 9]. Glue the two double-layered side parts on both sides of the four-layered grey cardboard middle. As you do this, check whether middle and side parts are all centred exactly. Next,

glue a small plastic bearing disc 14 x 4.1 mm onto each outer face with instant adhesive, also centring it precisely. After drying, install the pulley on the wooden axle and test whether the hole in the bearing disc is large enough to allow easy turning. If necessary, widen the hole as described before. – Repeat all with pulley 2 [parts B11 to B14, sheet 4 and B15 to B18, sheets 8 and 10].

Step 15: Dab a bit of oil on the areas of the axle where the plastic discs will have contact, to prevent squeaking. Install both pulleys on the wooden axle. Now glue one stopper [B19 and B20, sheet 19] on each projecting axle end, to keep the pulleys from falling off. Do this in the same fashion as before with the pulley axle covers. Be careful that the pulleys retain enough room between cover and stopper and are able to turn without friction. Finally, glue facings 1 and 2 [B21 and B22, sheet 19] on the ends of the pulley axle.

The driving wheel of the crank drive consists of a groove wheel, the glued-on crank arm with its handle and the crank shaft: a 56 mm long round wooden piece, glued into the centre the groove wheel. One of the crank shaft bearings is already installed inside the pedestal, the second one will be glued to the outside.

Step 16: Glue together the two parts of the outer crankshaft bearing [A42 and A43, sheet 4] and make sure that it fits into the side recess of the pedestal edge, below the pulleys, without trouble. OPTION: paint edges white or face with a white paper strip. Now glue one of the plastic bearing discs (25 x 4.1 mm) on one side of the outer crankshaft bearing.

IMPORTANT: The bearing is not to be glued on yet.

Step 17: Build the middle part of the driving wheel for the crank drive by glueing together the four parts [B23 to B26, sheet 5 and 6]. OPTION: paint edges black. Construct the

Section B: The Crank Drive

The belt drive wheels are all built basically in the same way: their core consists of 2 to 4 grey cardboard discs ("middle") coming to the same thickness as the belt that will run on them. Guiding the belt is a larger disc that is glued on each side and made of two layers ("inner" and "outer") of printed white cardboard. The crank drive itself is made of the driving wheel with its arm and handle as well as two pulleys. Motion is transferred to the central shaft runner by a belt of 4 mm diameter; which is why the middle parts of the involved wheels are built of four grey cardboard discs (see fig. 3).

front side of the driving wheel from parts [B27 and B29, sheet 11 and 13] and the back side from parts [B28 and B30, sheet 12 and 14]. Now glue front and back on the four-layered grey cardboard middle, aligning them well.

Step 18: With a pencil, make a mark exactly 11 mm from the end of one of the 56 mm long round wooden sticks. Take the crankshaft stopper [B31, sheet 19] and roll it over the stick so that it will bend well. Next, wrap and glue the strip next to the mark on the wood, leaving 11 mm free on one side. Push this 11 mm long end through the opening in the crankshaft bearing from behind, so that about 10.5 mm of wood project from the plastic bearing disc. Without glue, insert this wood end into the hole on the black back side of the driving wheel, so that it comes about 4 mm out of the front side. This way, the driving wheel is secured in its place on the outer crankshaft bearing by the stopper. It must be able to turn freely and easily, with not too much but also not too little leeway. Pull the wooden crank shaft out again and glue it into the position that you just tested. The crank arm will later be glued onto the 4 mm end of the projecting crank shaft.

Step 19: Insert the long end of the crankshaft into the side opening of the pedestal so that it locks into the central bearing, which is already glued into the pedestal wall and hidden from view. The outer crankshaft bearing will then slip into the side recess of the pedestal. Now apply some oil to those places on the wooden axle where the inner and outer plastic bearing discs have contact and glue the bearing on the pedestal wall edges in this position. Cover the remaining visible portions of the grey cardboard disc with facings 1 and 2 [A44 and A45, sheet 15 and 16].

Now the pedestal can be glued on the base plate:

Step 20: Mark the fibre direction, meaning the direction in which the cardboard is easier to bend, of parts [A47 and A48, sheet 15 and 16], the top and bottom side of the base plate. It is best to draw a line, running in the same direction, on the back of both parts, even before separating them from the sheet. Glue the two parts on both sides of the grey cardboard base plate [A46, sheet 2], in such a way that their fibre direction runs parallel. **OPTION:** colour edges white or face with white paper strips. Press well and long to prevent any warping of the baseplate.

Step 21: Push the central axle through the pedestal until half of it emerges at the bottom. Apply glue to the pedestal's glueing lashes, insert the end of the central axle into the hole in the base plate and push the pedestal down until the glueing lashes reach their destinations. Adjust the pedestal exactly and press lightly. After drying you can remove the central axle again.

IMPORTANT: The central axle is not to be glued in yet.

Step 22: As long as the central axle is not glued in, you can use it for shaping the sun globe bearing [K1, sheet 19]. In order to shape the paper strip into a tube, first wrap it around the wooden axle without glue to bend it. The black end should form the last bit. Now wrap the first turn without glue, then apply only a bit of glue and allow this portion to dry. Your care will achieve a close fit between wood and tube while allowing enough play for the tube to be pulled off easily. Now finish wrapping and glueing the strip into its tube shape and lay it aside; it will be needed only at the very end.

Step 23: Glue the four middle parts of the crank arm [B32 to B35, sheet 5 and 6] together. **OPTION:** paint the grey cardboard edges white or face with white paper strips. Glue the back and front [B36 and B37, sheet 15 and 16] on them. The crank arm has a larger wheel at one end, a small one at the other. Without glue, insert the crank handle axle (the 38 mm wooden stick) into the hole of the small wheel. Push the cover [B38, sheet 19] for the crank handle axle over the wood piece onto the crank arm and glue it in place.

Step 24: The paper strip for the crank handle axle (B39, sheet 19) must be wrapped and glued into a tube. It has to be able to turn on the wooden axle with a bit of play; therefore you need to first enlarge the round wood diameter a little. Use the last remaining 56 mm wood piece (the future Earth rotation shaft) as a wrapping tool and tape two layers of newspaper (or one layer of normal paper) around it with sellotape. Now wrap the paper strip once completely around this core, so that it is bent well. To begin now, wrap just a little more than one turn on the core and glue this piece to itself only.

IMPORTANT: Make sure that the tube is still moveable on the core and does not bond with it as you work on it.

Then wrap and glue the whole strip on and check that the layer edges are well aligned. After drying, pull off the finished capsule and also remove the additional paper from the round wood. Push the tube onto the crank handle axle.

TIP: if you intend to use the planetarium often, we recommend to wrap sellotape around the handle tube; this will protect the colours.

Step 25: Glue the tube stopper [B40, sheet 19] on the projecting wood end of the handle axle. For this it's best to pull the axle from the crank arm once more. Wrap and glue the stopper around the wooden axle end, aligning it with the edge, in the same manner as before (bending the paper, attaching the end with glue, wrapping and glueing the rest). Push the tube back on the axle and glue the wooden axle in its matching hole in the crank handle, just deep enough so that the tube can still turn easily with a bit of leeway. Glue the covers [B41 and B42, sheet 19] on both ends of the crank handle axle.

Step 26: Glue the crank handle on the driving wheel of the crank drive. The crank shaft end, which sticks out of the driving wheel centre, will enter into the crank handle hole. Glue its cover [B43, sheet 11] on this hole.

The crank drive is now finished. Next will be the central shaft which it drives.

Section C: The Central Shaft

The central shaft turns around the central axle. Its task is to receive the power coming from the crank drive by the running wheel at its lower end, and to pass it on to the planetary gearing at two differing speeds by way of the two driving wheels at its upper end. The core of the central shaft consists of the 100 x 12 mm cardboard tube (see fig. 4).

Step 27: Glue together the four-layered middle of the central shaft running wheel from parts [C1 to 4, sheets 5 and 6]. Before glueing, check whether the cardboard tube fits into every disc hole. If necessary, widen the hole as described at the start and/or sand the end of the cardboard tube. **OPTION:** paint the grey cardboard edges black.

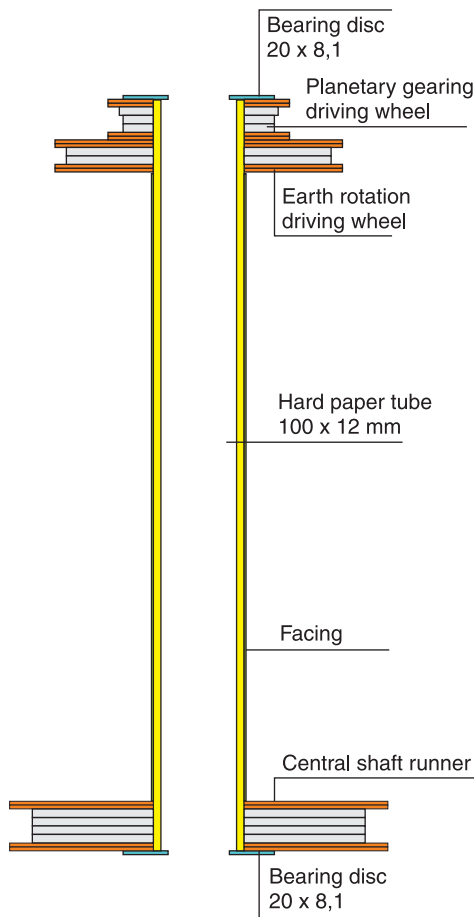

Fig. 4: Central shaft

Step 28: Glue the top side [C5, sheet 11] and the downside [C6, sheet 12] of the running wheel each to one of the insides [C7 and C8, sheet 13 and 14]. Now glue these double-layered guide discs on both sides of the central shaft running wheel, centring them precisely. Glue a plastic bearing disc (20 x 8.1 mm) on the black underside centre with instant adhesive.

Step 29: Insert the 10 cm cardboard tube into the top side of the running wheel so that it touches the bearing disc and stands at a right angle on the running wheel. Check this angle with a set square or paper corner. Then glue the cardboard tube into this position in the running wheel.

TIP: You will see at once whether the wheel is tilted or at a right angle to the cardboard tube if you put wheel and tube on the central axle in the pedestal and spin it.

Step 30: Glue together parts [C9 and C10, sheet 2] to build the middle of the Earth rotation driving wheel. Check whether the cardboard tube fits into the hole and do adjustments if necessary. **OPTION:** paint the grey cardboard edges black. Glue together the side guide discs: top and bottom parts [C11 and C12, sheet 11 and 12] and two inner parts [C13 and C14, sheets 13 and 14]. Then glue the guide discs on both sides of the grey cardboard middle.

With most of the groove wheels of the belt drive, the 2 mm drive belt leaves the wheel in a straight line. In these cases, the middle part of the groove wheel consists of two layers of grey cardboard, producing a sufficient space of 2.3 mm. The belt that drives the planetary transmission needs to be slanted, though, in order to connect the grooved wheels. To prevent its jumping the wheel, the grooves of both driving wheel and runner need to be wider. They are therefore built of three cardboard discs. One of these is a little larger than the others, providing a slightly asymmetrical running surface within the wheel.

Step 31: Build the driving wheel for the planetary gearing by, first of all, glueing the middle parts [C15 and C16, sheet 2] against one another with their upper sides, so that a small groove between the edges results. Now glue on the third middle part [C17, sheet 2], which is a bit larger, with its upper side. **OPTION:** paint the grey cardboard edges black. The small groove is now slightly off-centre in the three-layered disc. After drying, see to it that the cardboard central shaft fits well into the hole. Next, glue the top and bottom of the guide discs [C18 and C19, sheet 11 and 12] on their inner parts [C20 and C21, sheet 13 and 14]. The guide disc with gold printing should then be glued, well-centred, on the larger of the three grey cardboard discs; glue the second guide disc on the other side of the middle part.

Step 32: Lay the earth rotation driving wheel built in step 30 on your work surface with the grey glueing area looking up and glue the just constructed planetary gearing driving wheel on it, well centred. The side with gold print is on top, and next to it, the larger of the three grey cardboard discs. After drying, make sure that the central shaft fits into the hole and then glue the remaining plastic bearing disc (20 x 8.1 mm) on the centre of the small planetary gearing driving wheel with instant adhesive. Next, glue the two connected groove wheels on the free end of the cardboard tube so that the tube touches the plastic bearing disc. The wheels must be at an exact right angle to the cardboard tube and not tilted. To check this, you can put the central shaft on the central axle and spin it.

Step 33: Bend the central shaft facing [C22, sheet 19] by wrapping it around a pencil or around the central axle; then glue it on the central shaft cardboard tube. First glue on only the backside of the grey end, then wrap and glue the rest on.

The central shaft is now finished.

Section D: The Ecliptic Disc

The ecliptic disc determines the distance to the planetary gearing, which moves in a circular motion along the outer rim of the planetary gearing, as if on a rail. The rubber belts that press the planetary gearing against the outer rim exert considerable pressure on the ecliptic disc. In addition, the weight of the moving planetary gearing provides changing, irregular forces. Three structural features enable the ecliptic disc to withstand these potent stress factors: A solid rim reinforcement made of grey cardboard, a light yet torsion-free hollow construction and a solid mounting on the central axis.

Step 34: Lay the upper halves of the ecliptic disc [D1 and D2, sheet 7 and 8] side by side on your work surface, printed side facing down. The two halves will now be glued together using connector strips [D5 and D6, sheet 11 and 12]. Before you do this, make a pencil mark at each end of the line dividing the two halves – 10 mm from the rim. The connector pieces have to keep clear of this mark to leave room for the grey cardboard reinforcement that will run around the rim. Now glue the connector strips first on only one of the disc halves, parallel to the dividing line and leaving half of the strip projecting out. The distance to the rim is 10 mm, to the disc centre a good 18 mm. Now turn the disc halves face up, apply glue to the projecting connectors and lay the second disc half on them so that the rim edges meet exactly and a perfectly circular disc results. Repeat this procedure with the underside of the ecliptic disc [D3 and D4, sheet 9 and 10] and its connectors [D7 and D8, sheet 13 and 14]. The disc with the signs of the zodiac will become the top part of the ecliptic disc.

Step 35: Remove the 42 rim reinforcements [D9, sheet 1] from the grey sheet, taking care to remove all of the small connector residue, so that the curved outside edge is clean. In the next step you will glue these 42 pieces into six ring-like layers of 7 pieces each, forming a solid rim between the top and bottom part of the ecliptic disc.

IMPORTANT: Take care that your work surface is perfectly plane, to prevent any warping of the ecliptic disc during glueing.

Step 36: Glue the first reinforcing piece on the back of the ecliptic disc so that it bridges the middle joining line. Its outer curved edge has to be in line with the outer rim of the ecliptic disc. Now glue on the other 6 pieces that form the first layer, without any gaps between them. As you glue all the other pieces into mounting layers, bridge the underlying joints by shifting the pieces, as you would when laying bricks.

IMPORTANT: Pay careful attention to positioning also the upper layers exactly in line with the disc rim, so that none of the segments project beyond the edge. Use a set square or ruler to check this by holding the right-angled side against the ecliptic disc from the outside. It is not a problem, on the other hand, if one or other of the segments stand back from the edge, though.

Step 37: Take the six parts of the inner axle mounting [D10 – D15, sheet 3 and 4] and check if the wooden central axle will fit through the hole; then glue the six discs tightly on top of one another. Before it sets, install this block temporarily on the central axle without glue, and spin it. In this way you can check whether it is perpendicular to the axle and does not wobble. Remove the round wood and glue the block into the centre of the rim reinforcement, exactly above the hole in the middle of the ecliptic disc.

Step 38: Bend the 16 strips [D 16 – D31, sheet 15 and 16] and glue them into 16 distance rings of about 40 mm diameter, overlapping about 8 mm. As before, the rings do not need to look pretty and creases are

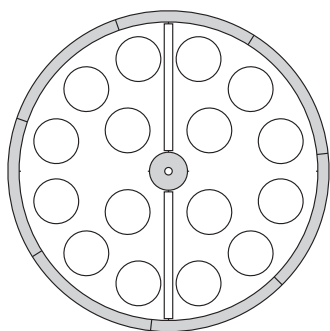

Fig. 5: Ecliptic disc with distance rings

acceptable, too. The ends, though, need to be perfectly in line, just like the pedestal distance rings in step 1. Now, glue the rings onto the lower ecliptic disc as shown in fig. 5. Use plenty of glue and position the rings in the area between the rim reinforcement and the axle mounting, without touching the connector strips. While they dry, press the rings down with your fingers again and again to make sure that they have complete contact.

Step 39: Position the top of the ecliptic disc on the lower part so that both upper and lower rim and the two middle joint lines are aligned among themselves. If the reinforcement rim projects in any place, use a knife or sandpaper to remove it. To glue top to bottom, use the same procedure as with the pedestal walls: apply plenty of glue to the distance ring edges and a little less glue to the reinforcing rim and the axle mounting, lay the top disc on this, with the edges aligned, and then turn the whole thing up-side-down so that the glue will run in the right direction. Weigh it down to press it so that all of the glueing areas will have tight contact.

IMPORTANT: Do not allow any of the rim edges to project beyond the ecliptic disc in any place, at top or bottom. Cut or file off anything that projects after drying.

Step 40: Bend rim facing 1 [D32, sheet 7] into a round shape by pulling it over a table edge and then glue it on the rim of the ecliptic disc so that 0° is aligned with March 21st and 90° with June 21st. The start of this rim facing will now also be aligned with the ecliptic disc's joint line. Continue with the other segments [D33 – 35, sheet 9 – 10]; the degree count has to rise from segment to segment; position the next joints at September 24th and December 21st. Should any gaps remain between the segments, fill them with small cardboard cuttings.

Step 41: The Earth inclination driving wheel, just like the planetary gearing driving wheel of step 31, is built around an asymmetrical middle of two identical and one slightly larger grey cardboard discs. First glue parts [D36 and D 37, sheets 3 and 4] with their top sides together, then glue the larger disc [D38, sheet 2] on it, so that, as before, an off-centre groove results. **OPTION:** paint grey cardboard edges black. Glue parts [D39 and D41, sheet 11 and 13] together to make the upper guide disc, and parts [D40 and D42, sheet 12 and 14] to make the lower guide disc (these parts are located in the centre of the Venus orbit disc). Glue the golden back side of the lower guide disc on that side of the middle piece where the larger of the three grey cardboard discs is located. Glue the other guide disc on the opposite side. Now glue the driving wheel's grey side on the golden underside of the ecliptic disc, aligning the holes exactly. The two smaller grey cardboard discs in the driving wheel, along with the small groove in the wheel's middle, should now be on the side that is closer to the ecliptic disc. Insert the central axle into the driving wheel and the ecliptic disc before the glue sets completely. Hold the central shaft like a handle and insert the central axle. You can now rotate the disc and see at once whether it is perpendicular to the axle, or if it wobbles.

Step 42: Push the central axle through the ecliptic disc so that exactly 23 mm of the wood emerge on top of the disc. Insert the long end into the central shaft, with the end carrying the two groove wheels pointing toward the ecliptic disc, and then push the central axle into the pedestal until it is level with the ground plate. The central shaft needs to have enough play so that it can turn freely and without resistance. If it has too much play, you can lower the ecliptic disc a little by twisting it back and forth. This will let a bit more of the central axle emerge. If it has too little play and is stuck between pedestal and ecliptic disc, you need to pull out the axle a little from the pedestal. Afterwards, mark the place where the round wood emerges with a pencil line all around the wooden axle.

Step 43: Pull central axle and ecliptic disc out of the pedestal together and check once more if the axle is perpendicular and does not wobble, using the central shaft as a handle. Push the axle out a further 20 mm from the ecliptic disc. Apply glue to it and then twist and pull it back in until the pencil mark reaches the disc. Check for 90° positioning again and let dry well.

Step 44: Remove 14 of the 18 upper axle mounting discs [D43, sheet 1, 5 and 6] from the grey cardboard. The rest is reserve material. Check if the discs can be pushed onto the central axle well but without play. **OPTION:** paint grey cardboard edges black. Apply glue to one underside after the other, pushing each of the 14 discs onto the projecting end of the central axis. Press them into a compact cylindrical block that is solidly connected to the ecliptic disc. Any glue that spills out the sides can be spread on the cylinder wall. As the block dries, check again whether the ecliptic disc is perpendicular to the central axle on all sides. The projecting end should now have a length of about 6 to 8 mm.

The central axle could be glued into the pedestal now. It is better to wait until the last step, which deals with the belts, though, because it will be easier to install them this way.

Section E: The Planetary Gearing

The function of the planetary gearing is to wander around the rim of the ecliptic disc in a rolling motion. It is made of a roller and several glued-on groove wheels. One of them is the large runner positioned beneath the roller. Inside, a hardpaper tube serves as a continuous hollow shaft, within which other parts can rotate at their own respective speeds (Earth inclination and Earth rotation). Owing to its rolling motion, the planetary gearing can drive both Venus and Mercury orbit discs by way of two groove wheels; this ability gives meaning to the gearing's name. The lunar orbit disc is glued fast to the planetary gearing, since its rotation and orbital periods are equal to those of the Moon in respect to Earth, even though the Moon is no planet in the Copernican definition (see fig. 6).

Step 45: The middle section of the planetary gearing runner is made of three grey cardboard discs as well; one of which is slightly larger. Take the two smaller parts [E9 and E10, sheet 5 and 6] first and glue their top sides together. Then glue the top side of the larger disc [E8, sheet 2] onto it. OPTION: paint edges black. Check if the 27 x 8.8 mm cardboard tube fits tightly into the hole; widen it if necessary. Glue the top side of the runner [E11, sheet 11] on inside no. 1 [E13, sheet 13], matching both parts' fibre direction as you did in step 20. Do the same with the underside [E12, sheet 12], glueing it on inside no.2 [E14, sheet 14]. Now glue the middle segment with the larger of the three discs exactly onto the centre of the backside of the gold-printed lower guide disc. The black top part goes on the other side.

Step 46: Using instant adhesive, glue one of the two 20 x 6.6 mm plastic bearing discs on the exact centre of the gold-printed underside of the planetary gearing runner. After drying, glue the 27 mm long hardpaper tube into the hole on the other side so that its end touches the bearing disc. Using a set

square and rotating the tube, see if it is at a precisely right angle to the runner.

Step 47: Remove the seven roller discs [E1 to E7, sheet 2] from the cardboard in such a way that nothing of the connecting bits remains on their edges. Make sure that they fit on the hardpaper tube that is now installed in the runner. OPTION: paint edges black. Now, without glue, push all seven discs on the tube with the same side facing down, and check whether they can be pressed together into a compact body without trouble. Then glue them into this position. Before it dries completely, check again for perpendicular position of tube and roller in relation to the runner. If necessary, sand the roller's cylindrical wall after drying to make it smoother, paint it if you wish and cover it with glue to toughen the soft cardboard surface.

Step 48: Glue parts [E15 and 16, sheet 2] together; this is the middle piece of the Mercury driving wheel. OPTION: paint edges black. Make sure again that the hole is wide enough for the hard paper tube. Glue top and bottom of the Mercury driving wheel [E17 and 18, sheet 7 and 8] each on one of the inside pieces [E19 and E20, sheet 9 and 10], then glue the resulting double layered guide discs well centred onto the middle piece.

IMPORTANT: Do the following step with extra care – it is responsible for the unhindered movement of the planetary gearing around the ecliptic disc.

Step 49: Without glue, install the Mercury driving wheel on the hardpaper tube, so that the underside with the flower design has contact with the roller. Hold it pressed on already. There should be a rectangular gap between the large runner and the smaller Mercury driving wheel. Its width matches the height of the roller. Now put the planetary gearing on the ecliptic disc rim, with the

Mercury driving wheel pointing up, and check carefully if it moves freely on all sides in its rolling motion. If you get the impression that this rolling motion is hindered somewhere, consider these possibilities:

- 1: The roller is not high enough, which would make the distance between runner and Mercury driving wheel too small; this will produce jamming everywhere. Solution: Install one or more of the washers [E21 and E22, sheet 19] on top of the roller. Only a little bit of play is required; in any case it is better to have a bit too much play than too little of it.
- 2: The rim facing of the ecliptic disc still projects beyond the edge in some places. Solution: Sand or cut off any excess material.
- 3: The roller came out slightly asymmetrical, its and the Mercury driving wheel's surfaces are not parallel to the large runner. This can jam the planetary gearing. Solution: Make the surface of the roller parallel by sanding off or adding on some material.

When you are satisfied with the mobility of the planetary gearing, you can glue the Mercury driving wheel onto the roller. Allow to dry well.

Step 50: Carefully remove the small discs [E33 and E34, sheet 2] for the steel pin base – they have a die-cut hole – from the grey cardboard parts of the lunar orbit discs [E31 and E32, sheet 2]. Punch through and widen this hole with a needle until it is large enough to take one of the 43.5 mm steel pins. Glue the slightly larger undersides of the two small discs together, then glue the matching printed disc [E37, sheet 17] on them after widening this hole also. Check again whether the steel pin can pass through all the way and is relatively vertical. This little block will be the Moon's steel pin base.

Step 51: Glue together the front sides of the middle parts of the lunar orbit disc [E31 and E32, sheet 2]. OPTION: paint edges black or white, or face with a white or a golden paper strip. After removing the reserve piece [R] from the underside [E36, sheet 18], glue it and the top side [E 35, sheet 17] on. Make sure that the planetary gearing hardpaper tube fits into the hole. Now push the little steel pin base temporarily and without glue into its destined hole in the lunar orbit disc. Insert the steel pin and keep pushing the little block from all sides until it has contact with the lunar orbit disc and the steel pin is in a perpendicular position to it. It should not project beyond the top of the lunar orbit disc. Glue it into this position and pull the steel pin out again. Glue the remaining plastic bearing disc (20 x 6.6 mm) on the very centre of the lunar disc top side with instant adhesive, covering the hole.

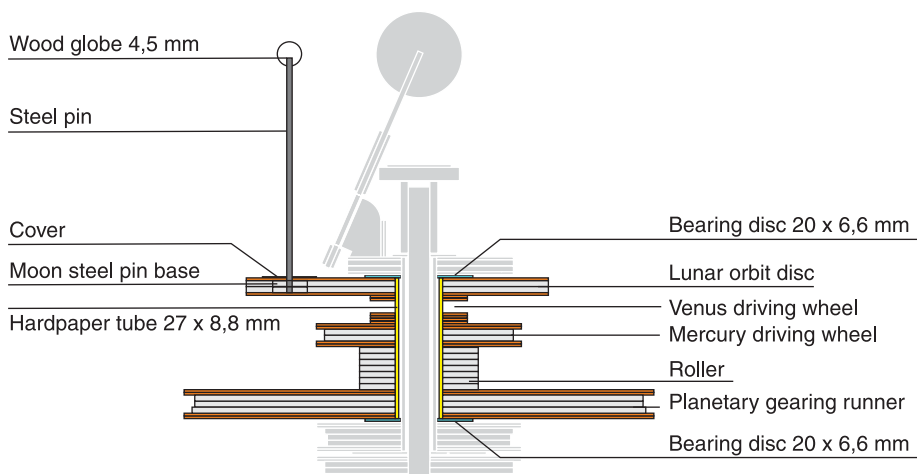

Fig. 6: Planetary gearing (light grey: earth inclination and earth rotation)

The Venus driving wheel is an exception in that it does not have a grey cardboard middle segment; the cardboard tube itself will serve this purpose. You will need only guide discs this time.

Step 52: Glue the inside of the Venus driving wheel [E25, sheet 11] and its top side [E27, sheet 13] together, then glue this double guide disc on the centre of the lunar orbit disc underside. If necessary, widen this hole, too. Push the four remaining parts of the Venus driving wheel [E26, E28 – E30, sheet 12, 14 – 16] without glue on the cardboard tube coming out of the Mercury driving wheel and push the lunar orbit disc on it also. There should be a gap now between the loose discs below and those discs which are glued on the lunar orbit disc. This gap should be at least 2 mm wide so that the drive belt can run within. Check the gap width with one of the provided drive belts. If the gap is too tight and the belt jams, you will have to pull the lunar disc out a little again. If it looks like you have to pull it too far for a reliable glueing, you can reduce the number of loose discs.

Step 53: Remove the lunar orbit and the loose discs from the cardboard tube again. **OPTION:** paint the cardboard tube black where it will be visible. Then, with glue, push the lower Venus driving wheel discs on the cardboard tube and also glue the lunar orbit on top, preserving the pre-determined 2 mm gap for the drive belt. Check whether the lunar orbit keeps parallel to the Mercury driving wheel by looking from the side and by rotating it.

The planetary gearing is now finished and ready to receive the earth inclination mechanism within which the earth rotation shaft moves.

Section F: The Earth Inclination Mechanism

As it orbits the sun, the Earth's inclined axis should always point in the same direction, as it does in reality. This necessitates a separate mechanical device, which connects the earth axis base with the stationary central axle and synchronizes them. The effect of this is that during one orbit the earth axis base revolves backwards one turn, so to say; which makes it appear to stand still. Strangely enough, it is hardly ever mentioned that Copernicus recognized this rotation as a third movement of the earth, beside its daily rotation and annual orbiting (see fig. 7).

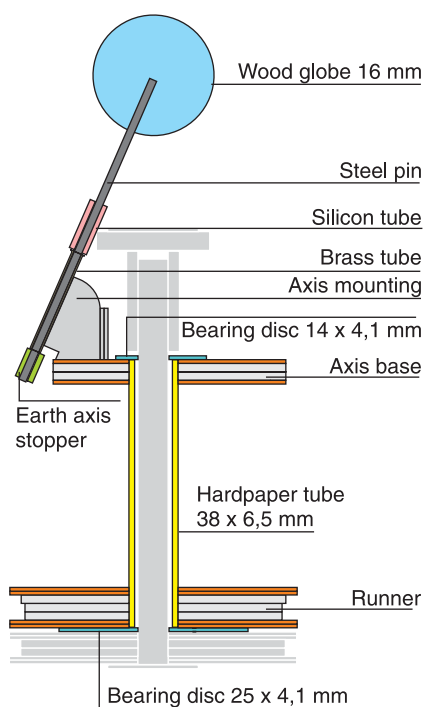

Fig. 7: Earth inclination
(light grey: earth rotation)

Step 54: Glue the middle parts of the axis base [F1 and F2, sheet 5 and 6] together. The round cut-out areas on the side must be exactly aligned. Use a knife to cut completely through the partly die-cut lines on the upper side of the axis base [F3, sheet 17]. The grooves that result will take the Earth axis mounting later on. The die-cut lines on the underside of the axis base [F4, sheet 18] will not be cut; this piece could serve as a reserve part if a wrong cut were made on the upper part. Now glue both sides on the middle part; try to allow as little glue as possible to run into the cut-out grooves. **OPTION:** Paint edges black or white or face with white or golden paper strip. Check if the 38 x 6.5 mm hardpaper tube will fit into the hole. Widen it if necessary. Put the last 14 x 4.1 mm plastic bearing disc on the centre of the upper side. It will cover part of the cut-out

grooves. With a straight cut, take off enough of the bearing disc so that it keeps about 1 mm distance to the grooves when its hole is centred exactly above the hole in the axis base. Glue into position with instant adhesive.

The earth axis mounting, which will be installed on the axis base, has an edge that is tilted 23.5° from the perpendicular line; this equals Earth's inclination. It is built of three inner pieces and two slightly wider outer parts with side supports, to which the back part will be glued (see fig. 8).

Step 55: Glue the three parts of the inner axis mounting [F5 – F7, sheet 10] together to form a small block. Fold both side axis mountings [F8 and F9, sheet 10] forward at

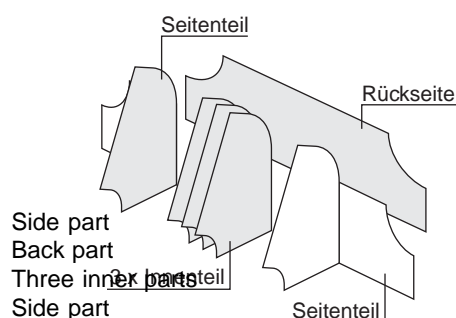

Fig. 8: Earth axis mounting

the die-cut lines. Each is made of one part that is similar to the inner mounting pieces, only wider, and a fold-away side support. Now glue the small block between the two similar-looking parts of the side pieces so that they end together at the round lower back side. At the front, on the sloped edge, will be a groove, because the side pieces project about 1 mm. This groove is three cardboard layers or about 1.5 mm wide and will take the brass tube that allows the Earth axis to turn within it. Now glue the two folded-away side supports onto the back of the axis mounting [F10, sheet 10], which shows the same round cut-outs at its ends. A diagram of the finished axis mounting will show a T with a short upward stroke and a very wide horizontal bar; it matches with the cut-wide horizontal groove on the axis base. Check now if it fits into the groove and, if need be, widen it with a sharp knife.

IMPORTANT: The lower edge of the axis mounting needs to enter completely into the groove, otherwise it would sit on the basis at a tilted angle. The inclination of the Earth axis would then be incorrect.

Step 56: First, push the brass tube into the inclined groove in the axis mounting, so that the funnel-like end is at the top and finishes with the cardboard parts. Glue it into this position with instant adhesive but do not allow any glue to run into the openings. Now glue the complete axis mounting into the T-like grooves.

TIP: Instead of constructing the earth axis stopper from paper as described in the next step, you can cut off about 3 mm of the silicone tube and install it on the Earth axis end. This is easier to remove, should maintenance work be necessary.

Step 57: Wrap and glue the narrow paper strip of the Earth axis stopper [F11, sheet 19] on the end of one of the steel pins. As before, bend it first by wrapping it on without glue. Then first glue on only the short edge with instant adhesive, followed by wrapping and glueing the rest into a roll with about 3 mm diameter that ends at the wire's tip. After drying, push the wire into the brass tube from below. The stopper will keep the Earth axis from being pulled out of the brass tube by the magnetic driving wheel. Now push the silicone tube onto the steel pin from above, only so far as to allow it to still turn freely within the brass tube. Spin the steel pin between your fingers to check its ability to turn easily and without hindrance. Remove any possible obstacle.

Step 58: Install one of the two 16 mm wood globes on the end of the steel pin and check whether it is exactly above the hole in the centre of the axis base. If it projects too far, shorten the steel pin with a wire cutter. You can glue the globe on already with instant adhesive, but if you wish to paint it, do so before glueing the globe in place. Install the 38 mm long hardpaper tube in the axis base and check if it enters easily into the lunar orbit disc and the planetary gearing. Now glue it into the axis base and check by turning it whether it is perpendicular and does not wobble.

Step 59: The Earth inclination runner is built of three middle parts, one of them slightly larger than the others. Glue the two smaller grey cardboard pieces [F12 and F13, sheet 3 and 4] together with their top sides, then glue the third, larger piece [F 14, sheet 2] on them. **OPTION:** paint edges black. Construct the upper and lower guide disc from parts [F15 and F17, sheet 15 and 17] and [F16 and F18, sheet 16 and 18], then glue the white top side onto the larger of the three grey middle discs; the lower disc, which has a small grey glueing area, goes on the other side. Make sure that the 38 mm hardpaper tube fits well into the hole. Using instant adhesive, glue the remaining 25 x 4.1 mm plastic bearing disc on the underside of the finished runner, where the two smaller grey cardboard discs are. Now insert the cardboard tube that carries the Earth

inclination base into the planetary gearing from above. Push the runner onto the projecting end of the tube, below the gearing. Check if runner and Earth axis base are able to turn freely. There should be just enough play above as well as below to enable unhindered movement. If there is too much play, the cardboard tube can be shortened a little. In those places where the plastic bearing discs will touch the cardboard tube, wrap cello-tape around it to reduce friction and protect them. Now glue the runner to the tube and check by rotating it several times whether it is vertical and does not wobble.

Section G: The Earth Rotation

Earth axis rotation is caused by a neodymium magnet, which pulls the silicone-covered steel pin toward its edge, forcing it to rotate as it turns (see fig. 9).

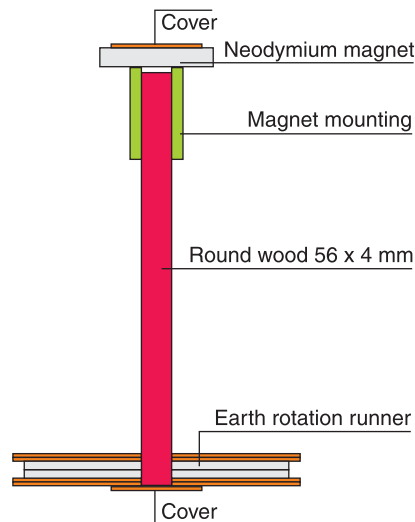

Fig. 9: Earth rotation

Step 60: Glue the paper strip [G1, sheet 19] into a 12 mm long tube, black on the outside, and with 4 mm internal diameter. Do this in the same way as before by wrapping it around the last remaining 56 x 4 mm round wood. The tube can be quite tight on the wood, but do not allow it to be glued to it in the least – you have to be able to pull it off afterward. Then, roughen the edge of the 15 x 2.5 mm neodymium magnet on one side with sandpaper. This will give it a better grip on the earth axis silicone tube. Glue the black

paper tube on the unsanded side of the magnet, using instant adhesive. Take care to position the mounting at a 90° position as well as in the centre of the magnet.

Step 61: Construct the middle of the Earth rotation runner from parts [G2 and G3, sheet 3 and 4]. **OPTION:** paint edges black. Now build the top side from parts [G4 and G6, sheet 15 and 16], and the lower side from [G5 and G7, sheet 15 and 16], then glue them on the middle pieces. Glue the cover [G8, sheet 12] beneath the hole in the underside and then glue the 56 mm round wood all the way into the hole. Check if it is at a 90° angle to the runner by turning it. Then glue the cover [G9, sheet 13] on the magnet's centre.

Step 62: From below, push the round wood through the hollow Earth inclination shaft and hold the magnet with its paper mounting into its place up above at the same time. It will attract the Earth axis with its edge at once. With a twist, push the wood end that is projecting at the top, into the tube and then check if the mounting is not too long. This would force the magnet into a tilted position. In this case, shorten the paper mounting a little. Also check the length of the wood; if it is too long, the runner will have too much distance to the Earth inclination runner above. In this case, shorten the round wood a little by setting the knife on the wood at the chosen cutting point and rolling the round wood back and forth. It is alright if the wood is a little shorter than the paper mounting on top, though.

IMPORTANT: Set the round wood into the magnet mounting without any glue, so that it is easier to disassemble in case adjustments or repairs are needed.

TIP: If the mounting is too loose on the round wood, you can apply a thin glue layer to either the end of the wood or the inside of the paper tube or to both. Remember, though, to let them dry well before reassembly.

The planetary drive, including the integrated moving elements, is now finished and you can go on to the inner planets Mercury and Venus.

Section H:

The Mercury Orbit Disc

The Mercury orbit disc cannot be driven directly by a belt because it would collide with the steel pin on the Venus orbit disc. Instead, a runner is driven, which is connected to the Mercury orbit disc that lies above it by a hollow shaft. The Venus orbit disc rotates around this shaft in turn (see fig. 10). – For production reasons, the upper side of the Mercury runner has to be assembled from the two pieces [H3 and H5], the underside from parts [H4 and H6].

IMPORTANT: The Mercury and Venus orbits (section J) are the largest grey cardboard discs. With their dimensions as they are, even a little bit of warping would be a problem. Before taking the pieces out of the sheets, then, mark their fibre direction, and let these be parallel when you glue the pieces together. If needed, bend them into shape gently before glueing. Allow to dry completely while being pressed.

If the doubled grey cardboard discs come out warped despite your best efforts, you can do the following: apply parallel cuts, 1 cm apart, on the hollow, concave side, parallel to the valley line, using a cutter and ruler. This takes the tension out of the disc and you can then bend it into shape, which will be made permanent when the top and bottom layers are glued on later.

Step 63: Mark the fibre direction on the middle of the Mercury runner [H1 and H2, sheet 3 and 4], then glue the two pieces together with aligned fibre directions. Press well. Mark the fibre direction on the top and bottom side as well as on the inside parts 1 and 2 [H3 and H4, H7 and H8, sheet 17 and 18], before removing them, by drawing a line

on each one, parallel to the longer edge of the sheet. Then, aligning the fibre direction, glue each of the insides against one of the top and bottom sides. These have a gap, into which you can glue the filler pieces [H5 and H6, sheet 17 and 18]. Press and let dry well. Now glue top and bottom sides of the Mercury runner on the grey cardboard pieces, so that the sides with the filled gap lie on the outside and the fibre directions are aligned. Again, press well during drying. Glue the last hardpaper tube (34 x 14.5 mm) into the hole so that it reaches the bottom and is perpendicular to the runner. Now glue the 50 x 29.3 mm plastic bearing disc over the hole in its underside, using instant adhesive and centring it well.

Step 64: Take the steel pin base pieces [H13 and H14, sheet 3 and 4] out of the cardboard middle parts of the Mercury orbit disc and widen the die-cut holes as you did before with the lunar orbit. Glue the printed cardboard part [H15, sheet 15] from the top side on them. Assemble the middle segment of the Mercury orbit from parts [H9 and H10, sheet 3 and 4], pressing them while the glue sets. **OPTION:** paint edges black or white or face with a white or golden paper strip. Glue the bottom side [H11 and H12, sheet 15 and 16] on this, again pressing well. Now push the steel pin base into its hole with glue, so that the steel pin (which is not to be glued in yet!) is vertical. Check if the disc can be installed on the hardpaper tube that is already in place in the runner; if necessary, widen the hole. Using instant adhesive, glue the other 50 x 29.3 mm plastic bearing disc exactly in the centre of the decorated top side of the Mercury orbit disc. After drying, set the orbit disc on the hardpaper tube and check if this ensemble of two discs and one hollow shaft can be installed on the upper axle mounting of the ecliptic disc. This block made of 14 grey cardboard discs will serve as an axle for the two plastic bearing discs. If the bearing discs are too tight and are unable

to turn, you will have to carefully scrape material off the inside. If less than one half of a grey cardboard disc emerges at the top, you may have to glue one of the reserve discs on it. This can also be done later at any point.

Section J:

The Venus Orbit Disc

For production reasons, the middle piece of the Venus orbit disc is ring-shaped; its centre had to be used for the inner Mercury segment.

Step 65: Construct the middle piece of the Venus orbit disc – which also serves as runner – from the two large rings [J1 and J2, sheet 3 and 4] by glueing them together with aligned fibre directions, and pressing them well to prevent any warping. If needed, apply parallel cuts as described in the last **IMPORTANT** box. **OPTION:** paint edges black. Mark the fibre direction on the back of the orbit disc's upper side [J3, sheet 11] and inner side 1 [J5, sheet 13]. Remove the small part [J11] that belongs to the steel pin base from the upper side, and also the corresponding reserve piece from the underside. Now glue the upper and inner side together in such a way that the small holes for the steel pin base lie above each other. Press well. Do the same with the underside [J4, sheet 12] and inner side 2 [J6, sheet 14], but do not remove the small discs marked [R] and do not place them above each other when glueing them.

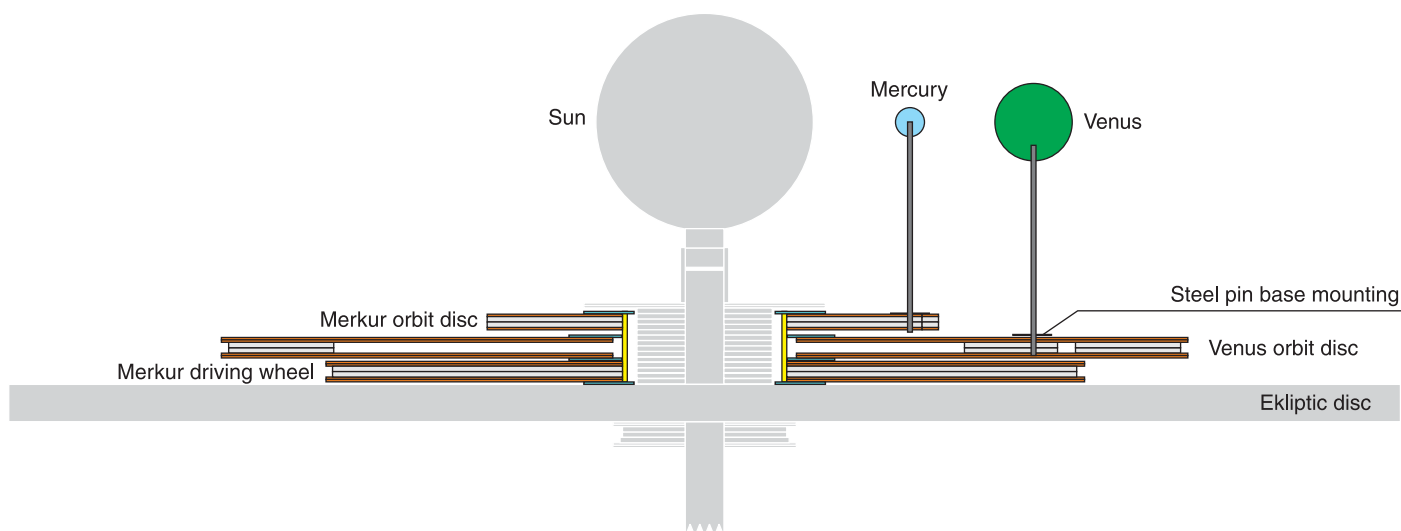

Figure 10: Mercury and Venus orbit discs (light grey: ecliptic disc with Sun)

Step 66: Remove the small steel pin base discs [J9 and J10, sheet 3 and 4] from the grey cardboard, widen the pin holes and glue them together. Glue disc [J11], from the upper side, onto the base discs. Now glue the two mounting pieces for the steel pin base [J7 and J8, sheet 3 and 4] together. These are disc-shaped, with one cut-off side. Lay the Venus orbit disc with its printed side down on your work surface so that the back side faces up. Now glue the steel pin base mounting [J7 and J8] over the small hole so that the cut side points out toward the rim. Then glue the ring-shaped, grey cardboard middle segment on the top side, centring it, and glue the underside on it as well. Press well while you allow to dry.

Step 67: Push and glue the steel pin base into its hole from the top and take care again to position the steel pin vertically. Glue the last two plastic bearing discs (55 x 34.3 mm) on the centre of the top as well as the bottom side of the Venus orbit disc. Take care to arrange them perfectly above each other. Now remove the Mercury orbit, which is not glued on, and check if the Venus disc can be installed on the hollow shaft in the Mercury runner. Also test its ability to turn freely on the shaft. If not so, widen the hole a little by scraping off material. Then return the Mercury orbit to its end position on the hollow shaft. If it holds well and tight you do not need to glue it on; this has the advantage that the Mercury-Venus-disc unit can be disassembled when needed. Remember that the Mercury orbit disc needs to be very parallel to its runner. Then set the whole unit on the axle block, which is situated on top of the ecliptic disc, and test everything for good mobility.

TIP: To reduce the wear on the grey cardboard axle block through abrasion by the plastic bearing discs, you can cover it with glue once more and wrap cello-tape around this after drying.

Step 68: Glue top and bottom side of the ecliptic disc cover [D44 and 45, sheet 17 and 18] together, aligning the fibre direction. Install the cover on the short protruding end of the wooden central axle. It should hold without glue to keep the Mercury-Venus-unit easily accessible.

Section K: The Sun

Our Sun is represented by the white plastic ball, which contains an LED that you can turn with the micro switch in the base. The Sun is connected to the central axle by a magnetic support.

Step 69: The paper tube that will now serve as a stopper for the Sun support was already made in step 22. Glue one of the 8 mm magnets into one of its ends. It has the same dimensions as the central axle, but you may still have to widen the tube end a bit to fit the magnet in. Afterward, install the tube on the central axle. This will also keep the cover underneath in its place. Set the second magnet on it, and on this the Sun globe, which has a flat base for this purpose. The centre point of the Sun should now be at about the same height as that of Earth, when the planetary gearing is installed on the ecliptic disc rim. Now glue the magnet into this position underneath the Sun globe with instant adhesive – but with the right side so that it does not repel the other magnet. To do this, sand the battery lid lightly to roughen the surface, then glue the magnet on this lid – not to the surrounding base, though, otherwise you would not be able to change the battery later.

The Copernicus Planetarium is now finished except for the transmission belts.

side walls [L3 and L4] on it, also with their tops, and in such a way that the outer edges align and a 2 mm gap is made between them.

Step 71: To become familiar with the glueing technique, first practice with a piece of the 4 mm round belt. Cut the ends of the belt at identical 45° angles, in order to increase the glueing surface. To do this, lay the ends, facing one another, on your cutting surface, overlapping about 1 cm and directly side by side. Secure them in place with a piece of sellotape (see fig. 11). Now position a set square or ruler on the belt at a 45° angle, push it down to hold the ends in place and then cut through them with a sharp knife. Remove the tape. You should now have two identical oval cuts at the ends. Roughen the surface up very gently with fine sandpaper and do not touch the cutting surfaces with your fingers.

Step 72: Put one end in the groove of the glueing form with the cut facing up, apply a small drop of instant adhesive to it and press the other cut end on it strongly. The two glueing surfaces have to be congruent, no edge projecting, and fitting tightly. Hold the ends in their place for some time and then slowly pull the belt out of the glueing board, not by pulling it up but rather by peeling it away to the side and from your fingers, too. Blow on the glueing area; this makes the glue set quicker. After some time, test the belt to see if it can withstand a light pulling force.

Step 73: Now cut off 32.5 cm of the 4 mm material and construct the thicker belt in its correct length with this. This length includes a 10 mm allowance for the overlap cuts.

Step 74: Next, do a few glueing tests with the 2 mm material also. Avoid producing strongly curved glueing surfaces and take into account that the instant adhesive may glue the belt to the grey cardboard surrounding the glueing spot, and also to your fingers. Always remove the belt by peeling it away, not by pulling, otherwise the still fresh glueing joint could come apart again.

Step 75: Now construct five rings out of the 2 mm material. For these, cut off the following belt lengths – each includes the 10 mm allowance already: 2 x 336 mm, 1 x 375 mm, 1 x 450 mm, and 1 x 555 mm. The three smaller ones will be installed beneath the ecliptic disc; the two larger ones are for Mercury and Venus.

Section L: The Drive Belts

You can skip the following section because your assembly kit contains pre-fabricated drive belts. Use this section when you wish to cut and shorten one of the belts or want to construct new ones from commercially available NBR-rubber string of 2 and 4 mm diameter.

Step 70: First, construct the glueing form for connecting the belts from the grey cardboard parts [L1 – L4, sheet 3 and 4]. Glue the two larger pieces [L1 and L2] together with their top sides; this will be the base. Glue the two

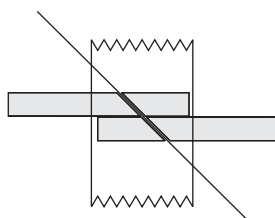

Fig. 11: 45° cuts of belt ends

Section M: Final Steps

TIP: Wipe the belts down with alcohol or a similar cleaner; this increases surface friction and makes the belts less likely to slip. Also stretch the rings before installing them on their wheels. The rubber material can easily take stretching up to almost double its length. If you have glued the rings yourself, stretch them only after the glueing joints have dried completely. Protect them by taking the joint between your fingers and stretching the ring with the other hand on the opposite side.

Step 76: Pull the central axle out of the pedestal, lay the pre-stretched 4 mm belt as well as the three smaller of the 2 mm belts on top of it and then insert the axle again.

Step 77: You can now glue the central axle into the pedestal. Pull it out of the pedestal, remove the central shaft and apply a bit of oil to the spots where the plastic bearing discs of the central shaft make contact. Then reinsert it, together with the central shaft, about halfway into the pedestal. The lower half of the rectangular space that holds the central axle has only two walls. From underneath, apply plenty of glue to these walls' last centimetres; then, twisting it, reinsert the axle into the pedestal to a depth which allows the central shaft free mobility, but with not too much play, as before. We recommend to align the ecliptic disc's middle joint line with the pedestal walls. Allow to dry well.

TIP: Once the central axle is glued in, any belts that need to be exchanged or repaired have to be pulled over the pedestal. This is more of an effort, but is easily done if the belts are stretched and perhaps warmed in addition.

Step 78: Pull the thicker belt onto the crankshaft driving wheel and its pulleys as well as onto the runner down by the central shaft. Check if it is set in motion when the crank handle is turned.

Step 79: Install the planetary gearing on the ecliptic disc rim. Pull one of the two smaller, thin rings onto the earth inclination driving wheel, which is connected to the underside of the ecliptic disc. Then pull the belt on the second runner from the bottom on the planetary gearing; this one is connected to the earth inclination base. Lay the other, smaller ring on the small groove wheel at the top of the central shaft and pull it on the large planetary gearing runner. Be aware that these two belts change levels as they run from driving wheel to runner; they cross over when looked at from the side (see fig. 12).

Before attaching the third belt you need to install a counterweight above:

Step 80: Pull the smaller of the two large rings onto the Mercury runner, which is hidden from view beneath the Venus orbit disc, and also onto the Mercury driving wheel of the planetary gearing, which rests on the upper side of the ecliptic disc. To do this, you may temporarily remove the Mercury and Venus orbits, which are not glued on. The Venus orbit itself is connected to its small driving wheel by the largest belt; this wheel is located directly underneath the lunar orbit disc.

Step 81: The last belt is to be put into position under the ecliptic disc by pulling it on the two remaining earth rotation drive groove discs. In this case the belt has to be twisted half a turn to form a horizontal 8, otherwise the Earth globe would turn in the wrong direction and the belt would also be much too loose. If you turn the crank handle now, all parts should move as desired. Solutions for possible problems are given in the last section.

Step 82: Using instant adhesive, glue the three steel pins into the steel pin bases of Moon, Venus and Mercury. Before glueing, thread one of the covers [E38, H17 and J13, sheet 11 to 13] on each of the pins; then cover the glueing areas with them. The pins must be in a very perpendicular position. Now install the globes on the steel pins temporarily: Moon (4.5 mm) is the smallest, Mercury (6mm) is medium size and Venus (16 mm) the largest. With instant adhesive, glue them on so that they are all at about the

same level as the imaginary line between the centres of Sun and Earth. If one of the pins is too long, shorten it. If the centre of the Sun is higher than that of Earth, you can shorten the tube on which it rests.

OPTION: If you wish to paint the globes, do so before glueing them on. For this, bend open a paper clip and push the globe on its end. **TIP:** do not use glossy paints and apply a primer coat first, for example with correcting fluid. **EARTH:** draw in only the equator and four meridians (lines from pole to pole); or paint the globe blue and add white cloud layers (correcting fluid) plus a thin equator line ("our blue planet"); or indicate the continents ... there is no limit to what you may do! **MOON:** white – this will make the Moon phases more distinctive in the dark. **VENUS:** copper red (copper is the metal traditionally associated with Venus); or green (also a traditional association). **MERCURY:** yellow – one of the traditional colours of Mercury.

You have now finished the construction of the Copernicus Planetarium. Congratulations! With much skill and patience you have built a valuable astronomical demonstration apparatus. It would surely deserve prominent exhibition, but is even more suitable for showing, understanding and learning purposes.

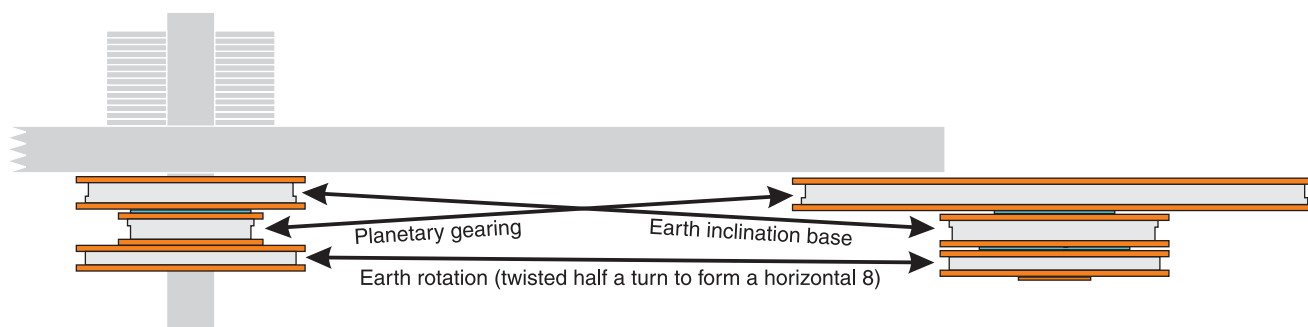

Figure 12: Drive belt installation below the ecliptic disc

Things you can demonstrate with the Copernicus Planetarium:

As observers on Earth, we have the sensation of being in the centre of all that we see. This world view, which was also at the core of antiquity's concept of the world, is still valid in our time, especially in our daily lives, which are ruled by nature's rhythms. After all, at dawn we speak of the sunrise and not of the "earth-turn". Concepts based on the Copernican world view, though, where the focus of our thinking is moved to the Sun, supply an especially simple and plausible physical explanation and are therefore no less valid. If you have clear knowledge about the point from which you observe and explain some object, then you can understand and accept both world definitions at the same time. This can be compared to touching a glove – you would sense and describe it very differently depending on how you encountered it: from the inside or the outside.

In this sense the Copernicus Planetarium is a useful tool for explaining well-known phenomena experienced on Earth only, from a point of view that encompasses the whole solar system. The sizes of Earth, Moon and the planets are represented in correct relation (the Sun's is not); the distances, though, are nowhere near correct – this would blow any model's proportions. The orbital times are about correct in comparison to astronomical facts. One crank turn will move everything one week further. Please be aware that a belt-driven transmission is always subject to some slip; this produces deviations.

- The change of night and day and the Sun's course through the day correspond with the daily rotation of Earth on its axis. (For technical reasons the Earth globe goes through 5 instead of 7 rotations per crank turn, which is hardly noticeable, though.)
- The course of the year with its change of seasons corresponds with the orbit of Earth around the Sun (about 52 crank turns). The inclined Earth axis keeps its direction throughout the orbital period, this lets the Northern hemisphere receive more light at one time and the Southern hemisphere at another. To demonstrate this, turn the Earth inclination base until the (upper) North pole of the Earth globe points toward the Sun when positioned at the June 21st marking (summer solstice).
- The zodiac is the traditional series of twelve star constellations in which the terrestrial observer sees the Sun in the course of one year.
- The changing of the Moon phases is caused by the varying position of the Moon in relation to Earth and Sun. One half of the Moon is illuminated by the Sun all of the time, but it shows this half to us only at full moon; at other times we are shown less and nothing at all during new moon. The particular phase symbol on the lunar orbit disc which points toward the Sun, indicates the Moon phase visible from Earth at the time. During one annual Earth orbit, the Moon passes through all of its phases about 12 and 1/3 times (this equals about four crank turns per month). The Moon always turns the same side towards Earth.
- Lunar and solar eclipses happen when the Moon enters Earth's shadow or when Earth is hit by the Moon's shadow. Information: Owing to the unavoidably incorrect relative distances in this model, every full moon position causes a lunar eclipse, while every new moon brings about a solar eclipse. This, of course, is not so in reality.

If you wish to demonstrate only the above phenomena, you can remove the Mercury and Venus orbits. The model would then be called a "Tellurium" – an Earth-Moon-Sun model. The planetary drive would in this case be held in place by the lower drive belts only.

- Venus is recognized as the morning star when the observer on Earth sees it to the right of the Sun. It will then rise before the Sun does. We see Venus as the evening star when positioned to the left of the Sun; it will then set after it.
- The phases of Venus can be observed with a telescope only. They appear when only a fraction of sunlit Venus is visible from Earth.
- The superior and inferior conjunctions of Mercury and Venus appear when the planet in question is exactly in front of the Sun (inferior) when seen from Earth, or exactly behind it (superior conjunction). Unlike Moon and the so-called outer planets Mars, Jupiter, Saturn and so on, Venus and Mercury can never be in opposition – meaning, in the opposite direction to the Sun when seen from Earth.
- The pentagram of Venus conjunctions is made by connecting those points on the zodiac with each other where Sun and Venus stand during a superior conjunction as seen from Earth (the same goes for the inferior conjunctions). Generally, this is seen as the reason for associating the pentagram symbol with Venus; a connection known since antiquity. In relation to the Mercury conjunctions there is a similar connection: the Mercury triangle, though this is not as commonly used.
- The sidereal orbit time of a planet or of the Moon describes the duration of a complete orbit around the Sun until it reaches the same fixed star (lat. sider) again. Mercury takes 88, Venus 225 and the Moon 27 ¼ days for this (as observed from Earth).
- The synodic orbit time of a planet or of the Moon is the time it takes to reach the same position in relation to the Sun again, as seen from Earth. Mercury takes 116, Venus 584 and the Moon 29 ½ days (one lunation, the time from new moon to new moon).

Having problems? Here are some possible solutions:

1. Earth turns the wrong way: Does the Earth rotation belt cross over, like a lying 8?
2. The illuminated halves of the planets are not clearly distinguishable: Is the surface of the globes rough enough to prevent reflecting? Perhaps you need to cover up the reflecting surfaces of the Mercury and Venus orbit discs for certain demonstrations?
3. The orbit times differ strongly from the ideal times: Does the transmission encounter too much resistance in any place? Is one of the plastic bearing discs too tight on its axle? Is there too much friction or even jamming in some part of the mechanism?
4. The pulleys squeak when cranking: Apply a drop of machine oil, or, even better, silicone oil (do not use edible oils) next to the bearing discs with a toothpick.
5. The glued joints of the drive belts do not hold (only applies to self-constructed belts): Do the glueing surfaces have flat contact? Are they grease-free and sanded lightly? Are you using a good, fresh instant adhesive? If done well, the bonds will withstand even high tension.
6. A slipping drive belt: Are the belts degreased sufficiently? TIP: If not in use for longer periods, it is a good idea to take the belts off; they will then regain their original tensile force. Replacement belts can be obtained through the AstroMedia customer service.
7. A drive belt jumps its groove wheel: perhaps you need to straighten a bent groove edge and harden it with glue? Is one of the groove wheels at a wrong angle, or is it warped? Are there grooves that are too tight and need to be widened by running a blunt-tipped instrument through them?

Do you have any other suggestions for solving difficulties? Please send word to: service@astromedia.de.

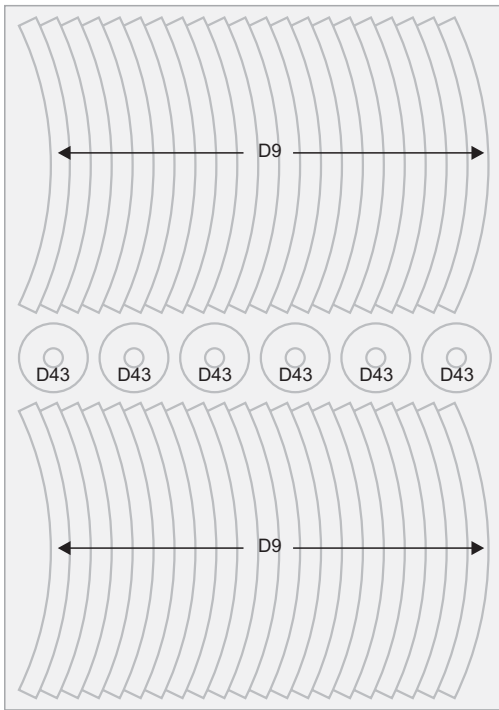

Bogen 1

Bogen 2

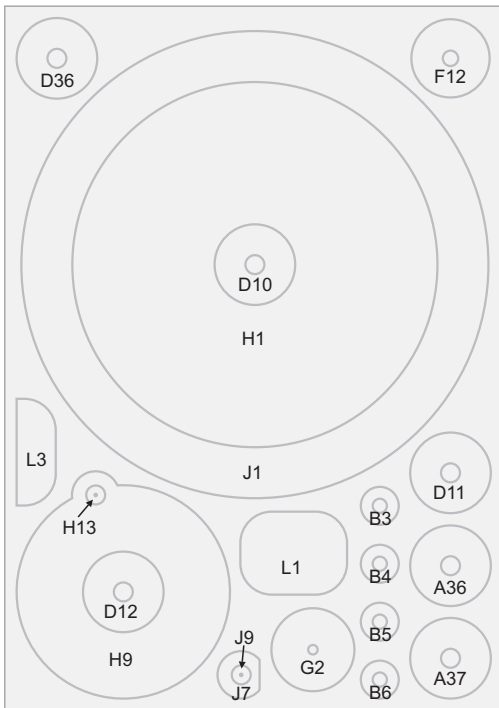
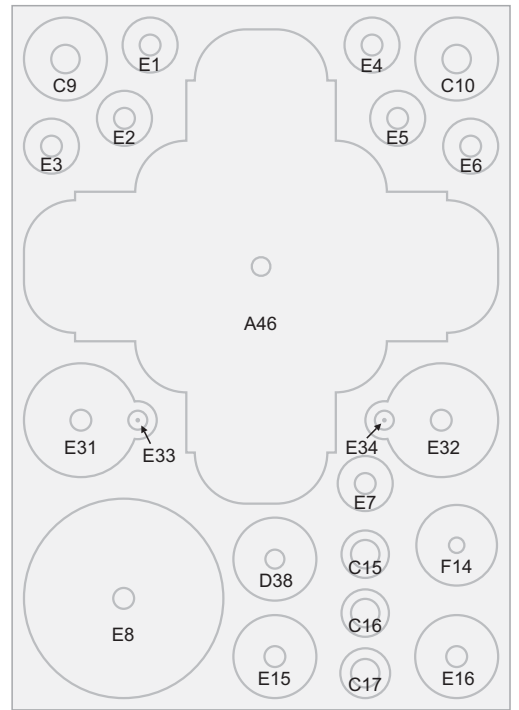

Bogen 3

Bogen 4

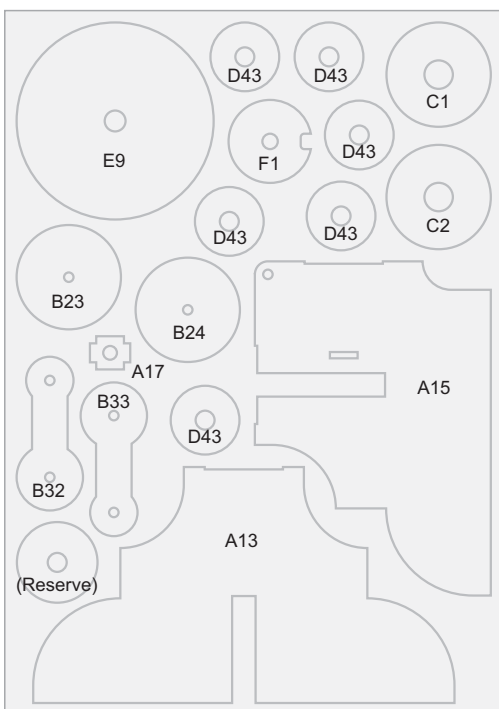
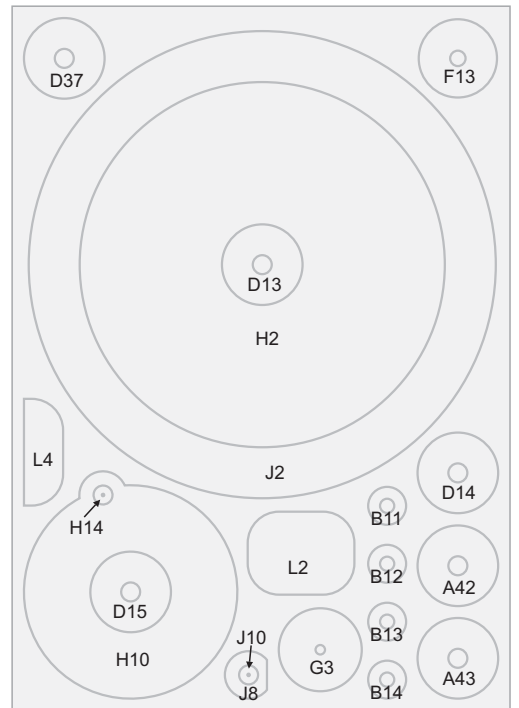

Bogen 5

Bogen 6

